

CMOS Multifunction Expandable 8-Input Gate

High-Voltage Types (20-Volt Rating)

The RCA-CD4048B is an 8-input gate having four control inputs. Three binary control inputs — Ka, Kb, and Kc — provide the implementation of eight different logic functions. These functions are OR, NOR, AND, NAND, OR/AND, OR/NAND, AND/OR and AND/NOR.

A fourth control input, Kd, provides the user with a 3-state output. When control input Kd is high, the output is either a logic 1 or a logic 0 depending on the inner states. When control input Kd is low, the output is an open circuit. This feature enables the user to connect this device to a common bus line.

In addition to the eight input lines, an EXPAND input is provided that permits the user to increase the number of inputs into a CD4048B (see Fig. 2). For example, two CD4048B's can be cascaded to provide a 16-input multifunction gate. When the EXPAND input is not used, it should be connected to VSS.

The CD4048B-series types are supplied in 16-lead hermetic dual-in-line ceramic packages (D and F suffixes), 16-lead dual-in-line plastic packages (E suffix), 16-lead ceramic flat packages (K suffix), and in chip form (H suffix).

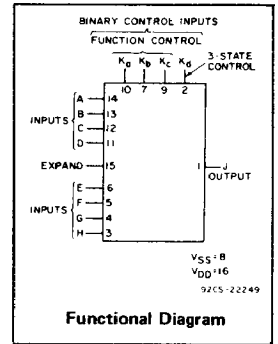

MAXIMUM RATINGS, Absolute-Maximum Values:

DC SUPPLY-VOLTAGE RANGE, (V _{CC}) (Voltages referenced to V _{SS} Terminal)	-0.5 to +20 V
INPUT VOLTAGE RANGE, ALL INPUTS	-0.5 to V _{DD} +0.5 V
DC INPUT CURRENT, ANY ONE INPUT	±10 mA
POWER DISSIPATION PER PACKAGE (P _D):	
For T _A = -40 to +60°C (PACKAGE TYPE E)	500 mW
For T _A = +60 to +85°C (PACKAGE TYPE E)	Derate Linearly at 12 mW/°C to 200 mW
For T _A = -55 to +100°C (PACKAGE TYPES D, F, K)	500 mW
For T _A = +100 to +125°C (PACKAGE TYPES D, F, K)	Derate Linearly at 12 mW/°C to 200 mW
DEVICE DISSIPATION PER OUTPUT TRANSISTOR	
For T _A = FULL PACKAGE-TEMPERATURE RANGE (All Package Types)	100 mW
OPERATING-TEMPERATURE RANGE (T _A):	
PACKAGE TYPES D, F, K, H	-55 to +125°C
PACKAGE TYPE E	-40 to +85°C
STORAGE TEMPERATURE RANGE (T _{stg})	-65 to +150°C
LEAD TEMPERATURE (DURING SOLDERING):	
At distance 1/16 ± 1/32 inch (1.59 ± 0.79 mm) from case for 10 s max.	+265°C

Features:

- Three-state output
- Many logic functions available in one package
- Standardized, symmetrical output characteristics
- 100% tested for quiescent current at 20 V
- Maximum input current of 1 μA at 18 V (full package-temperature range), 100 nA at 18 V and 25°C
- Noise margin (full package-temperature range) = 1 V at V_{DD}=5 V, 2 V at V_{DD} = 10 V, 2.5 V at V_{DD}=15 V
- 5-V, 10-V, and 15-V parametric ratings
- Meets all requirements of JEDEC Tentative Standard No. 13A, "Standard Specifications for Description of 'B' Series CMOS Devices"

Applications:

- Selection of up to 8 logic functions
- Digital control of logic
- General-purpose gating logic
 - Decoding
 - Encoding

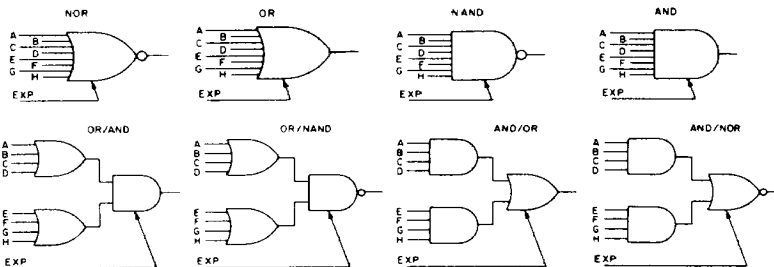

Fig. 1 - Basic logic configurations.

92CM 22250

RECOMMENDED OPERATING CONDITIONS

For maximum reliability, nominal operating conditions should be selected so that operation is always within the following ranges:

CHARACTERISTIC	LIMITS		UNITS
	MIN.	MAX.	
Supply-Voltage Range (For T _A = Full Package Temperature Range)	3	18	V

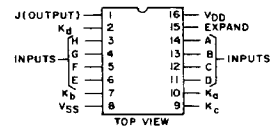

92CS-20248R1

TERMINAL ASSIGNMENT

CD4048B Types

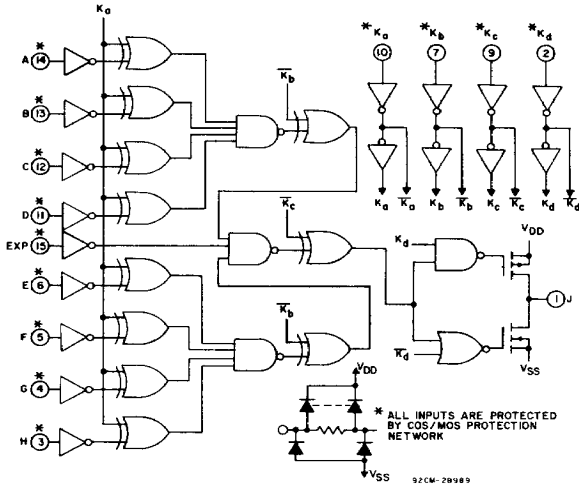

Fig. 2 - Logic diagram.

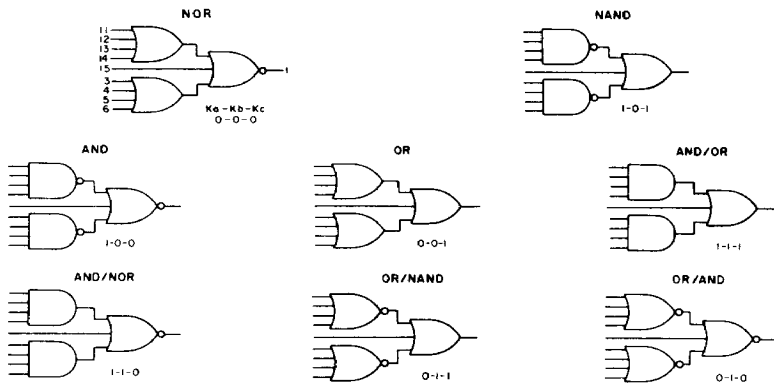

Fig. 3 - Actual-circuit logic configurations.

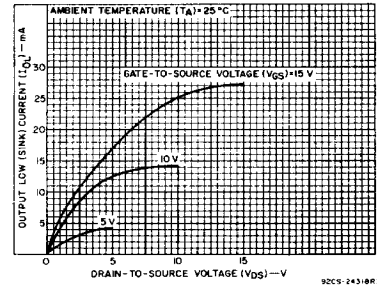

Fig. 6 - Typical output low (sink) current characteristics.

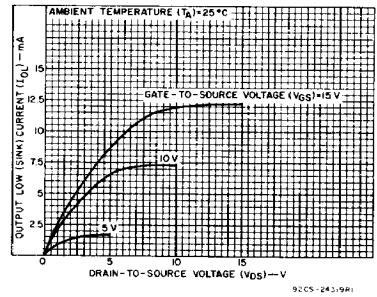

Fig. 7 - Minimum output low (sink) current characteristics.

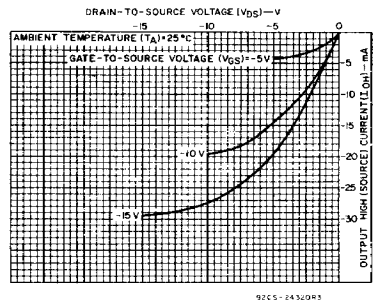

Fig. 8 - Typical output high (source) current characteristics.

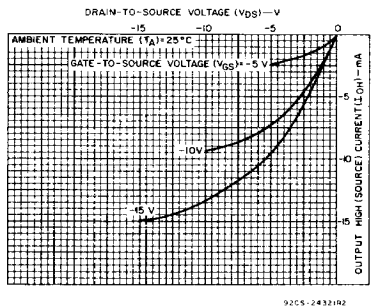

Fig. 9 - Minimum output high (source) current characteristics.

APPLICATIONS OF EXPAND INPUT

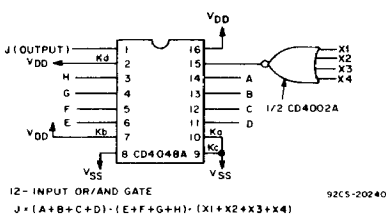

Fig. 4 - 12-input OR/AND gate.

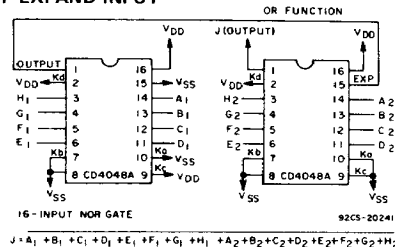

Fig. 5 - 16-input NOR gate.

CD4048B Types

STATIC ELECTRICAL CHARACTERISTICS

CHARACTERISTIC	CONDITIONS			LIMITS AT INDICATED TEMPERATURES (°C)							UNITS
	V _O (V)	V _{IN} (V)	V _{DD} (V)	Values at -55, +25, +125 Apply to D, F, K, H Packages				Values at -40, +25, +85 Apply to E Package			
				-55	-40	+85	+125	Min.	Typ.	Max.	
Quiescent Device Current, I _{DD} Max.	-	0,5	5	0,25	0,25	7,5	7,5	-	0,01	0,25	μA
	-	0,10	10	0,5	0,5	15	15	-	0,01	0,5	
	-	0,15	15	1	1	30	30	-	0,01	1	
	-	0,20	20	5	5	150	150	-	0,02	5	
Output Low (Sink) Current I _{OL} Min.	0,4	0,5	5	0,64	0,61	0,42	0,36	0,51	1	-	mA
	0,5	0,10	10	1,6	1,5	1,1	0,9	1,3	2,6	-	
	1,5	0,15	15	4,2	4	2,8	2,4	3,4	6,8	-	
Output High (Source) Current, I _{OH} Min.	4,6	0,5	5	-0,64	-0,61	-0,42	-0,36	-0,51	-1	-	mA
	2,5	0,5	5	-2	-1,8	-1,3	-1,15	-1,6	-3,2	-	
	9,5	0,10	10	-1,6	-1,5	-1,1	-0,9	-1,3	-2,6	-	
	13,5	0,15	15	-4,2	-4	-2,8	-2,4	-3,4	-6,8	-	
Output Voltage: Low-Level, V _{OL} Max.	-	0,5	5	0,05				-	0	0,05	V
	-	0,10	10	0,05				-	0	0,05	
	-	0,15	15	0,05				-	0	0,05	
Output Voltage: High-Level, V _{OH} Min.	-	0,5	5	4,95				4,95	5	-	V
	-	0,10	10	9,95				9,95	10	-	
	-	0,15	15	14,95				14,95	15	-	
Input Low Voltage, V _{IL} Max.	0,5,4,5	-	5	1,5				-	-	1,5	V
	1,9	-	10	3				-	-	3	
	1,5,13,5	-	15	4				-	-	4	
Input High Voltage, V _{IH} Min.	0,5,4,5	-	5	3,5				3,5	-	-	V
	1,9	-	10	7				7	-	-	
	1,5,13,5	-	15	11				11	-	-	
Input Current I _{IN} Max.		0,18	18	±0,1	±0,1	±1	±1	-	±10 ⁻⁵	±0,1	μA
3-State Output Current, I _{OUT}	0,18	0,18	18	±0,4	±0,4	±12	±12	-	±10 ⁻⁴	±0,4	μA

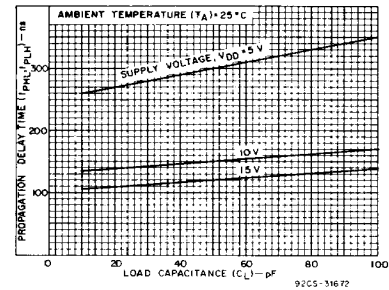

Fig. 10 - Typical propagation delay time (logic inputs to output) as a function of load capacitance.

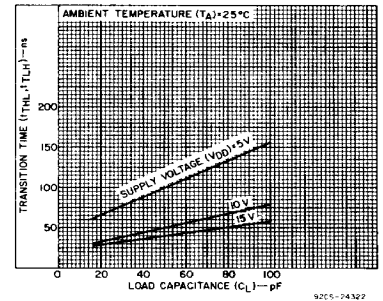

Fig. 11 - Typical transition time vs. load capacitance.

IMPLEMENTATION OF EXPAND INPUT FOR 9 OR MORE INPUTS

OUTPUT FUNCTION	FUNCTION NEEDED AT EXPAND INPUT	OUTPUT BOOLEAN EXPRESSION
NOR	OR	$J = (A+B+C+D+E+F+G+H) + (\overline{EXP})$
OR	OR	$J = (A+B+C+D+E+F+G+H) + (\overline{EXP})$
AND	NAND	$J = (AB C D E F G H) \cdot (\overline{EXP})$
NAND	NAND	$J = (AB C D E F G H) \cdot (\overline{EXP})$
OR/AND	NOR	$J = (A+B+C+D) \cdot (E+F+G+H) \cdot (\overline{EXP})$
OR/NAND	NOR	$J = (A+B+C+D) \cdot (E+F+G+H) \cdot (\overline{EXP})$
AND/NOR	AND	$J = (AB C D) + (E F G H) + (\overline{EXP})$
AND/OR	AND	$J = (AB C D) + (E F G H) + (\overline{EXP})$

Note: (EXP) designates the EXPAND function (i.e., $X_1 + X_2 + \dots + X_N$).

NOTE:
Refer to FUNCTION TRUTH TABLE for connection of unused inputs.

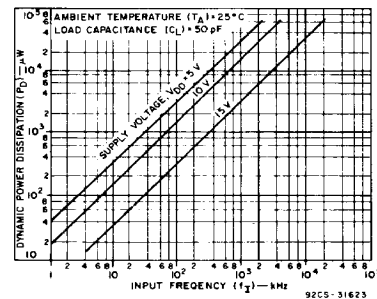

Fig. 12 - Typical power dissipation as a function of input frequency.

CD4048B Types

DYNAMIC CHARACTERISTICS at $T_A=25^{\circ}\text{C}$, $C_L=50\text{ pF}$, Input $t_r, t_f=20\text{ ns}$, $R_L=200\text{ k}\Omega$ unless otherwise specified

CHARACTERISTIC	TEST CONDITIONS	LIMITS		UNITS	
		V _{DD} V	All Package Types		
			Typ.	Max.	
Propagation Delay: t_{PHL}, t_{PLH} Inputs to Output and Ka to Output		5	300	600	ns
		10	150	300	
		15	120	240	
Kb to Output		5	225	450	
		10	85	170	
		15	55	110	
Kc to Output		5	140	280	
		10	50	100	
		15	40	80	
Expand Input to Output		5	190	380	
		10	90	180	
		15	65	130	
3-State Propagation Delay: Kd to Output t_{PHZ}, t_{PLZ} t_{PZH}, t_{PZL}	$R_L=1\text{ k}\Omega$ See Fig.21	5	80	160	
		10	35	70	
		15	25	50	
Transition Time: t_{THL}, t_{TLH}		5	100	200	
		10	50	100	
		15	40	80	
Input Capacitance: C_I	Any Input		5	7	pF
3-State Output Capacitance			5	10	

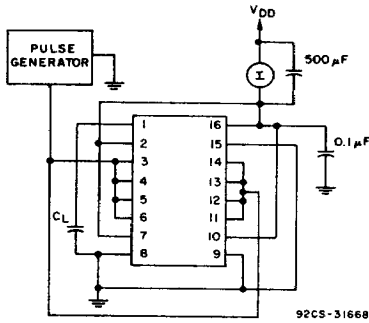

Fig. 13 - Dynamic power dissipation test circuit.

FUNCTION TRUTH TABLE

OUTPUT FUNCTION	BOOLEAN EXPRESSION	K _a	K _b	K _c	UNUSED INPUT*
NOR	$J=A+B+C+D+E+F+G+H$	0	0	0	V _{SS}
OR	$J=A+B+C+D+E+F+G+H$	0	0	1	V _{SS}
OR/AND	$J=(A+B+C+D)\cdot(E+F+G+H)$	0	1	0	V _{SS}
OR/NAND	$J=(A+B+C+D)\cdot(\bar{E}+\bar{F}+\bar{G}+\bar{H})$	0	1	1	V _{SS}
AND	$J=ABCDEFGH$	1	0	0	V _{DD}
NAND	$J=\bar{A}\bar{B}\bar{C}\bar{D}\bar{E}\bar{F}\bar{G}\bar{H}$	1	0	1	V _{DD}
AND/NOR	$J=\bar{A}\bar{B}\bar{C}\bar{D}+EFGH$	1	1	0	V _{DD}
AND/OR	$J=ABCD+EFGH$	1	1	1	V _{DD}

$K_d=1$ Normal Inverter Action
 $K_d=0$ High Impedance Output

EXPAND Input=0

* See Figs. 1,2,3,4, and 5.

TEST CIRCUITS - STATIC MEASUREMENTS

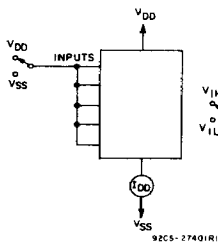

Fig. 14 - Quiescent device current test circuit.

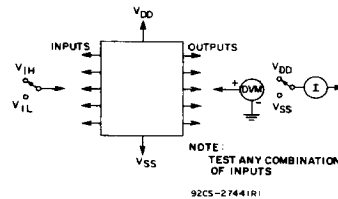

Fig. 15 - Input voltage test circuit.

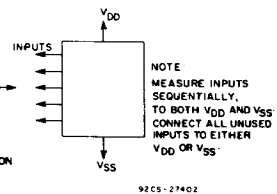

Fig. 16 - Input current test circuit.

TEST CIRCUITS - DYNAMIC MEASUREMENTS

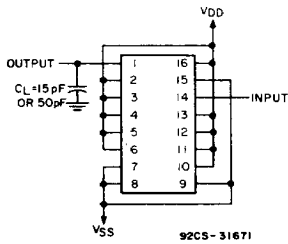

Fig. 17 - Test circuit for t_{PHL} , t_{THL} , and t_{TLH} (AND) measurements.

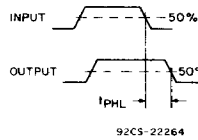

Fig. 18 - Waveforms for t_{PHL} and t_{PHL} (AND).

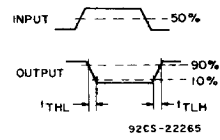

Fig. 19 - Waveforms for t_{THL} and t_{TLH} (AND).

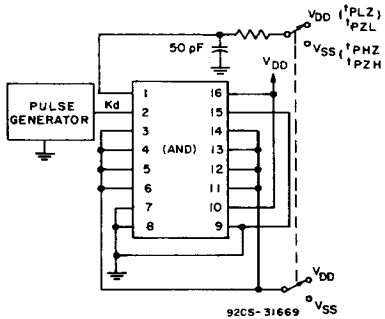

Fig. 20 - Test circuit for t_{PZL} , t_{PZH} , t_{PLZ} , and t_{PHZ} (AND).

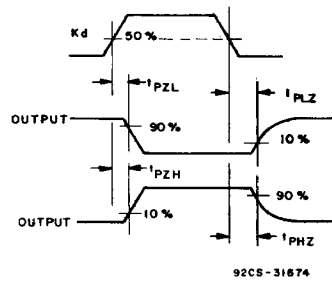
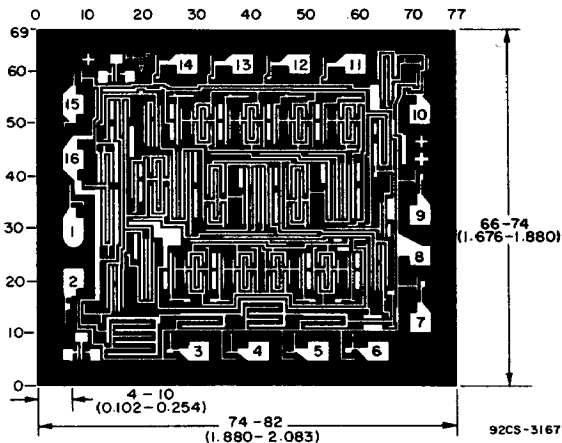

Fig. 21 - Waveforms for t_{PZL} , t_{PZH} , t_{PLZ} , and t_{PHZ} (AND).



Dimensions and pad layout for CD4048BH.

Dimensions in parentheses are in millimeters and are derived from the basic inch dimensions as indicated. Grid graduations are in mils (10^{-3} inch).

The photographs and dimensions of each CMOS chip represent a chip when it is part of the wafer. When the wafer is separated into individual chips, the angle of cleavage may vary with respect to the chip face for different chips. The actual dimensions of the isolated chip, therefore, may differ slightly from the nominal dimensions shown. The user should consider a tolerance of -3 mils to $+16$ mils applicable to the nominal dimensions shown.